

## CATALOGO CABINE:

CABINE STANDARD ENEL:.....	2
COE01-DG2061.....	2
COE01-DG2092.....	3
CABINE MT/BT .....	4
COE02-DG2092.....	4
CABINE FOTOVOLTAICHE .....	5
CFV01    250 kW.....	6
CFV02    500kW.....	7
CFV03    750kW.....	8
CFV04    1000kW.....	9

**CABINE STANDARD ENEL:**

COE01-DG2061

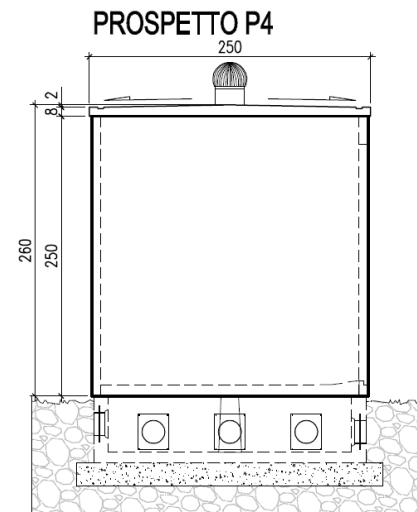
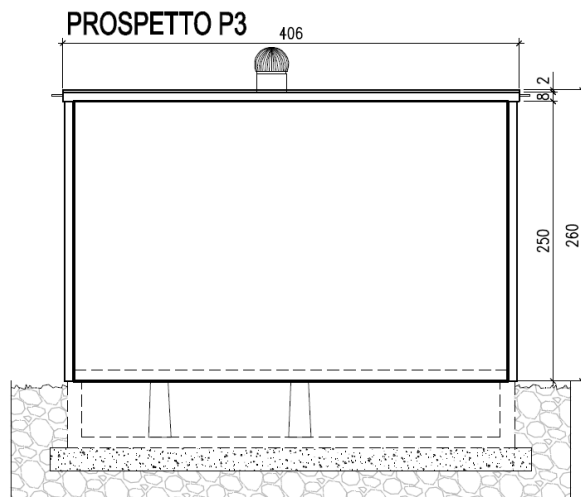
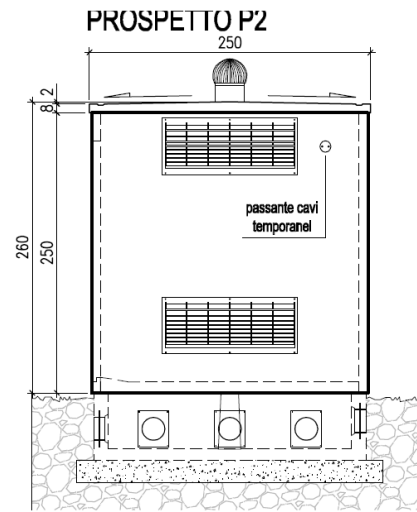
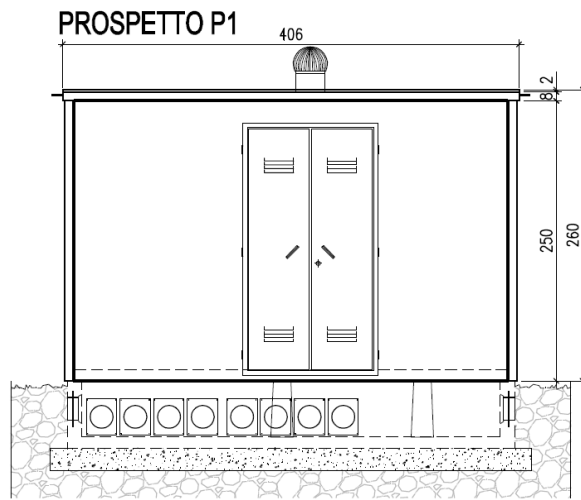

COE01-DG2092

PIANTA SOLAIO

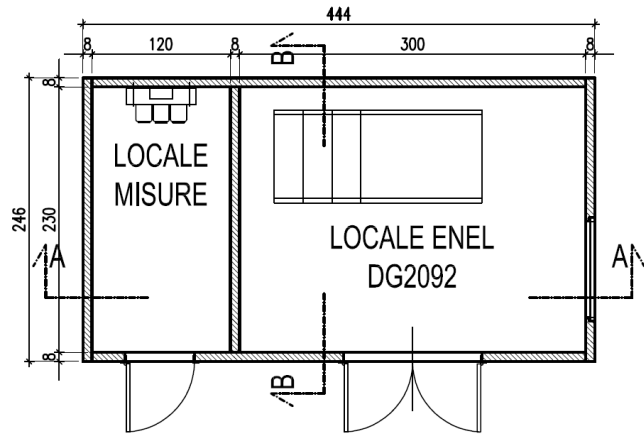

SEZIONE A-A

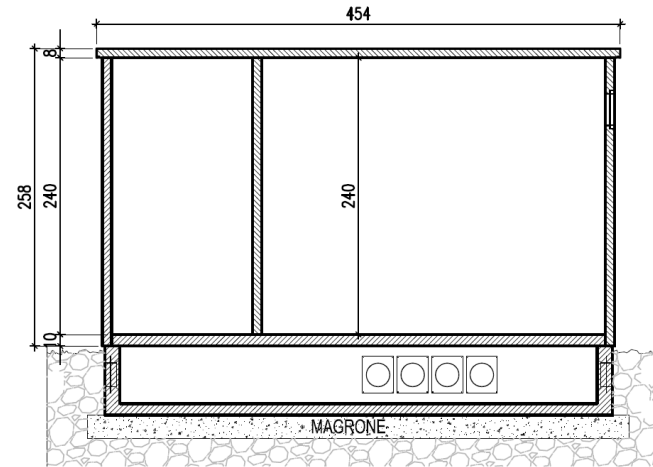

PIANTA COPERTURA

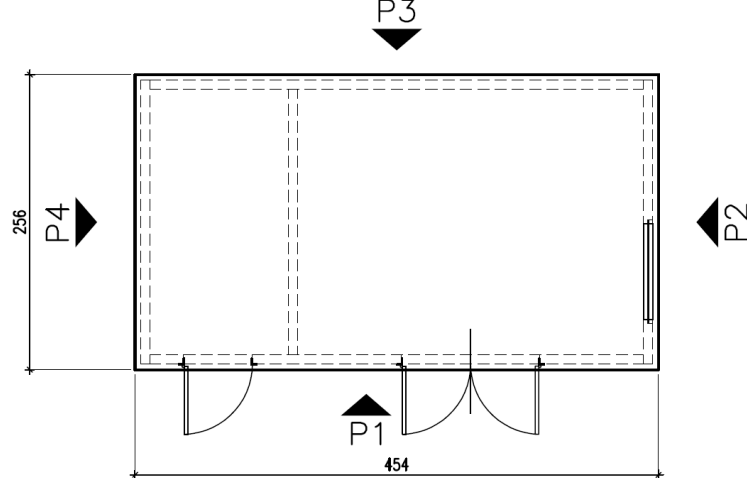

SEZIONE B-B

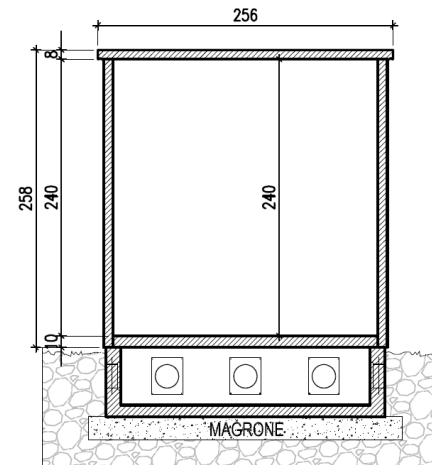

**CABINE MT/BT**

COE02-DG2092

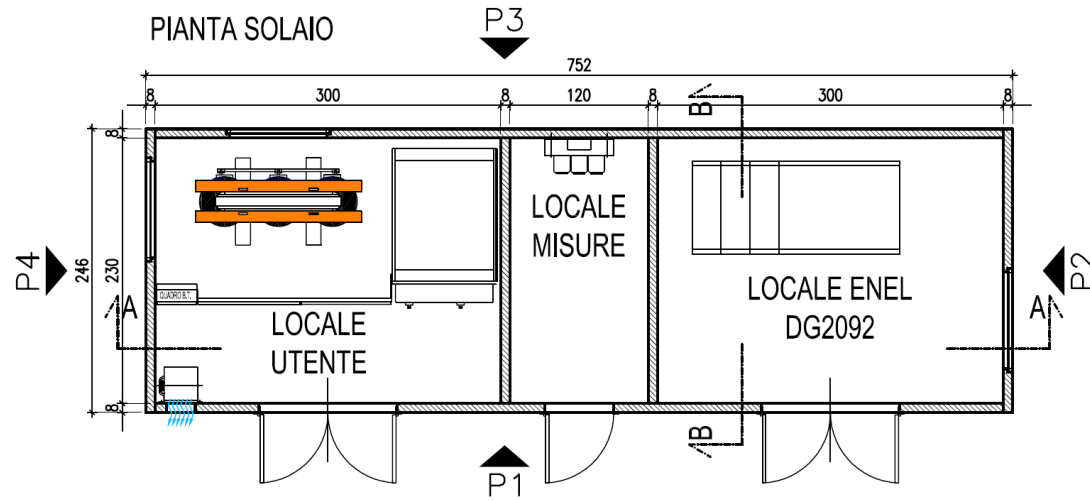

SEZIONE A-A

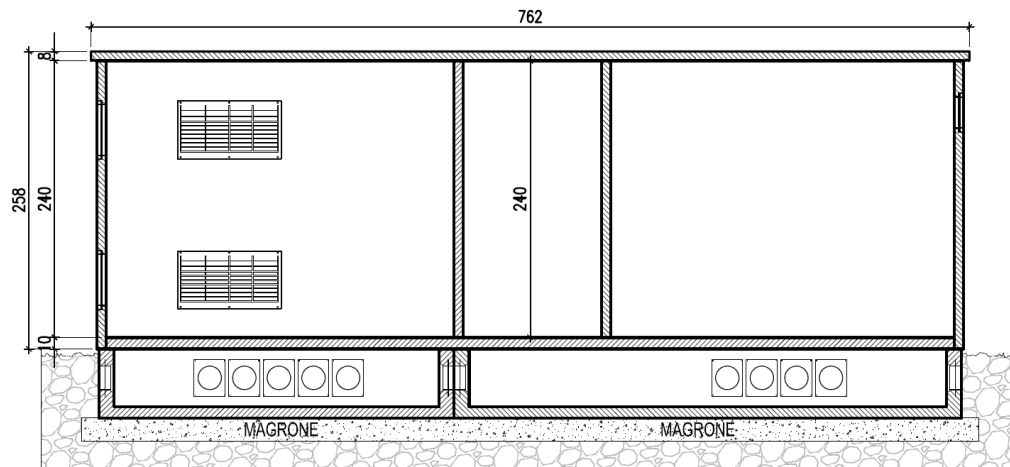

SEZIONE B-B

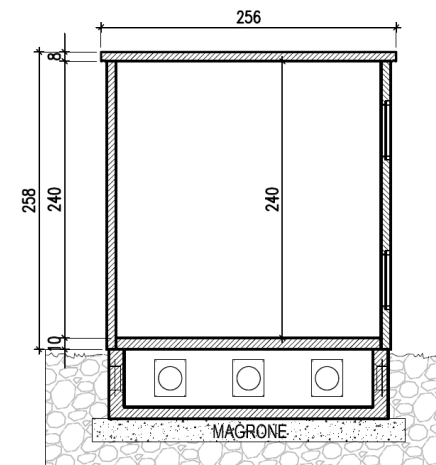

COE03-DG2092

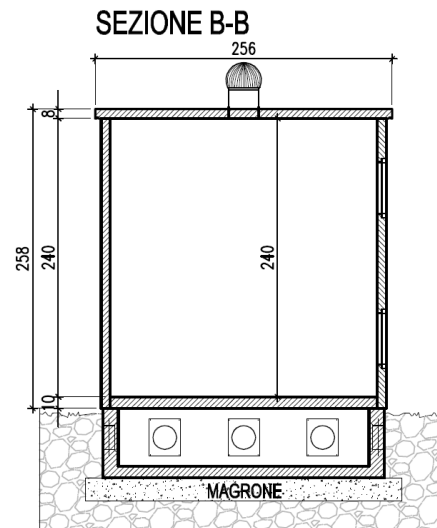
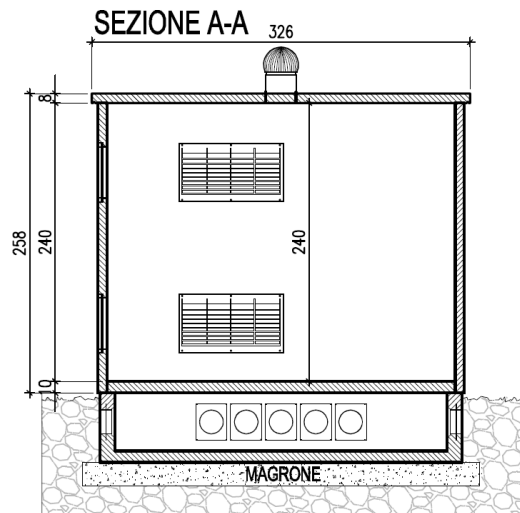
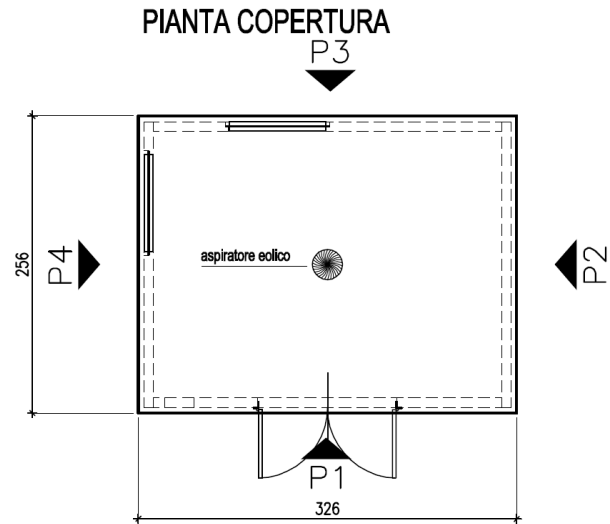
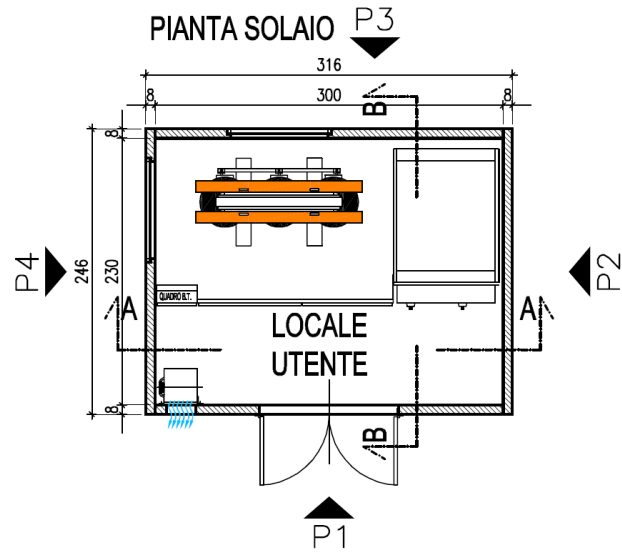

# CABINE FOTOVOLTAICHE

CFV01 250 kW

PIANTA

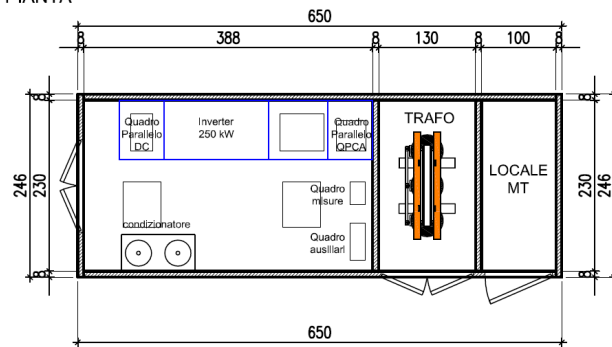

PIANTA COPERTURA

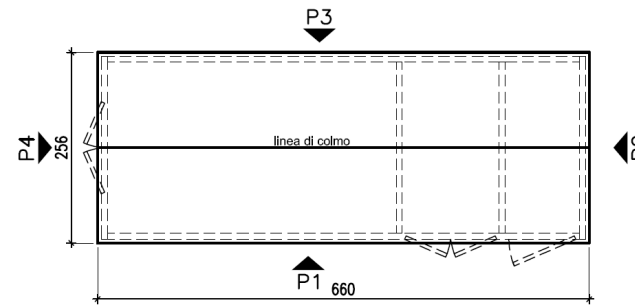

PROSPETTO P1

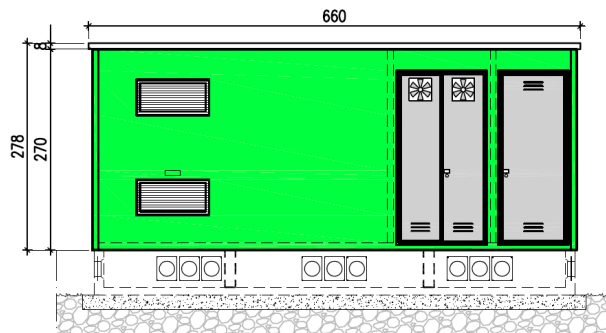

PROSPETTO P2

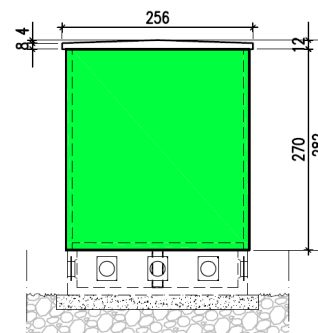

SEZIONE

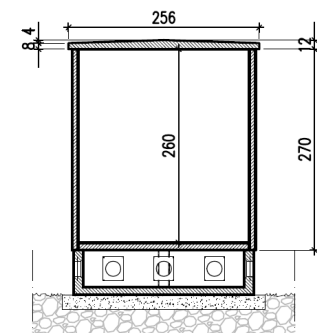

PROSPETTO P3

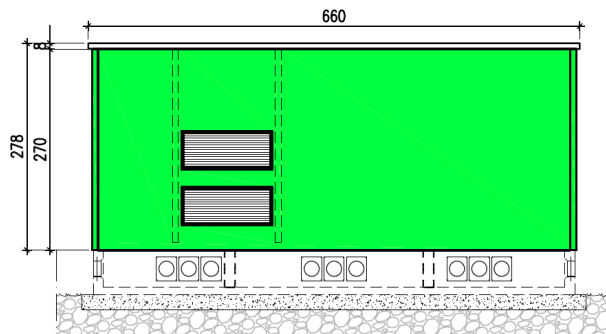

PROSPETTO P4

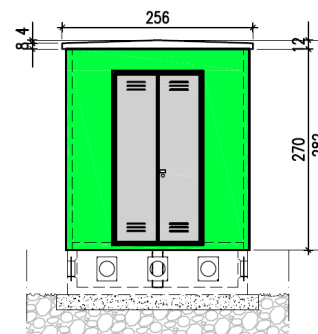

## CFV02 500kW

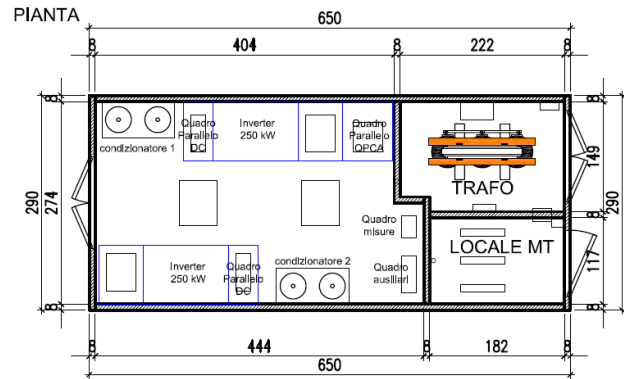

PIANTA COPERTURA

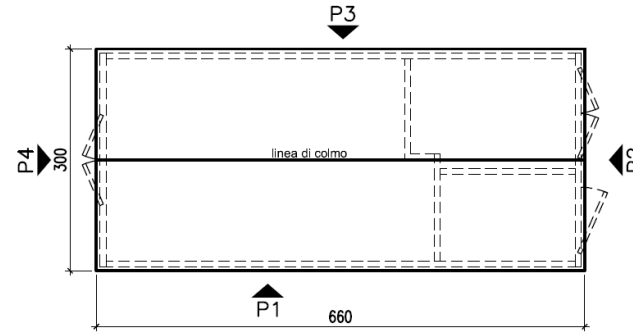

PROSPETTO P1

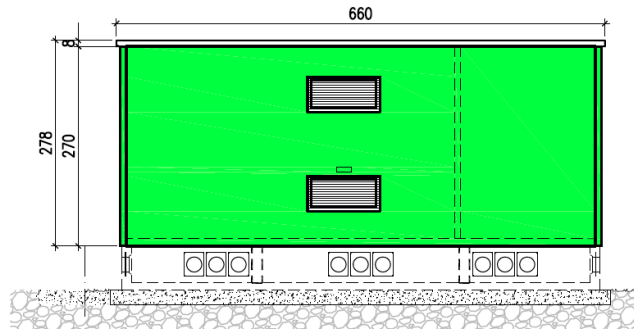

PROSPETTO P2

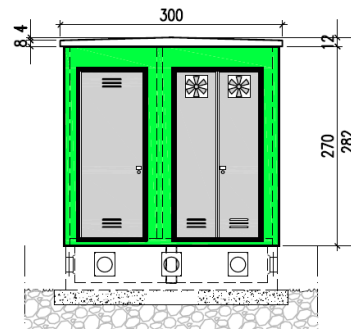

SEZIONE

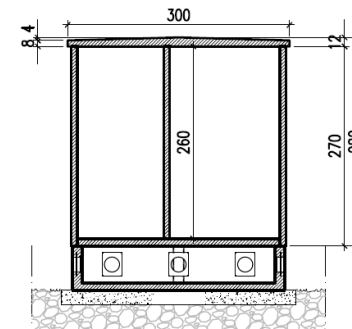

PROSPETTO P3

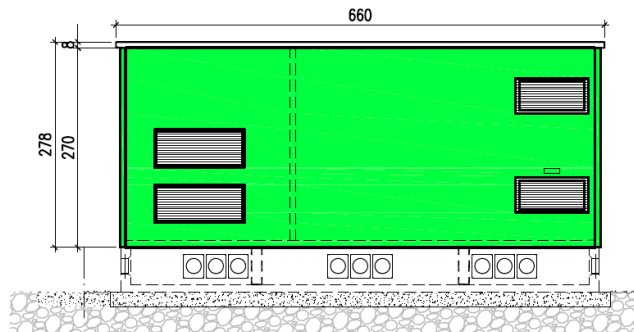

PROSPETTO P4

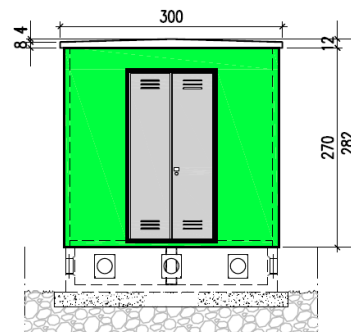

## CFV03 750kW

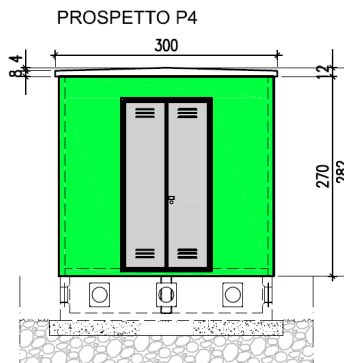
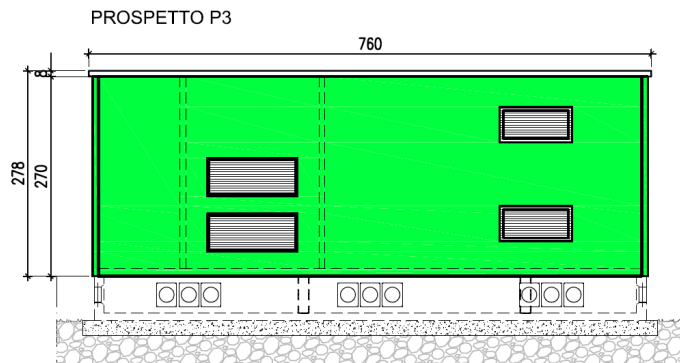
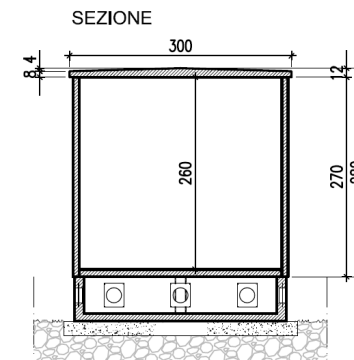
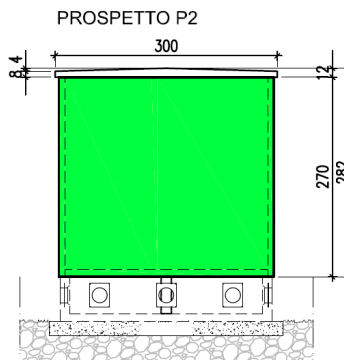
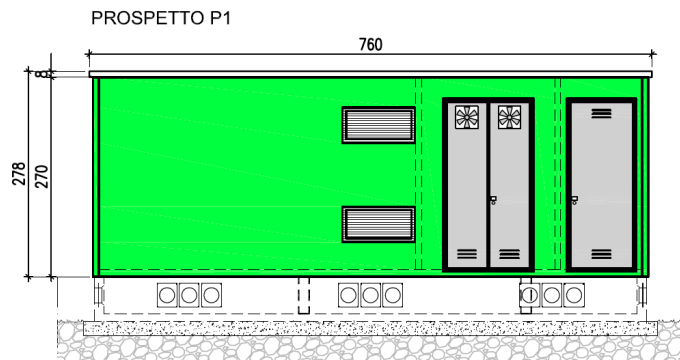
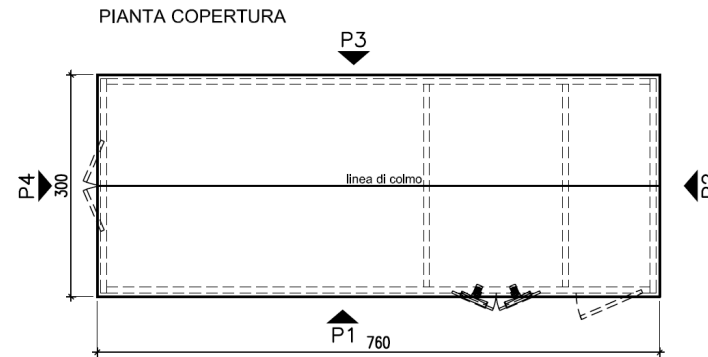
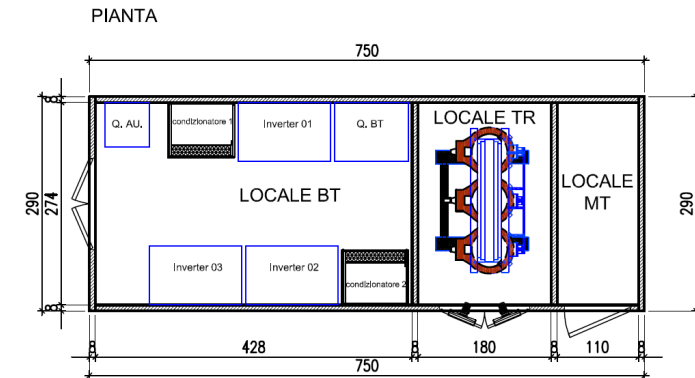

GLI INVERTER CONFIGURABILI  
 POSSONO AVERE TAGLIE DA  
 165 kW - 220 kW - 275 kW - 330 kW  
 CADAUNO.



## CFV04 1000kW

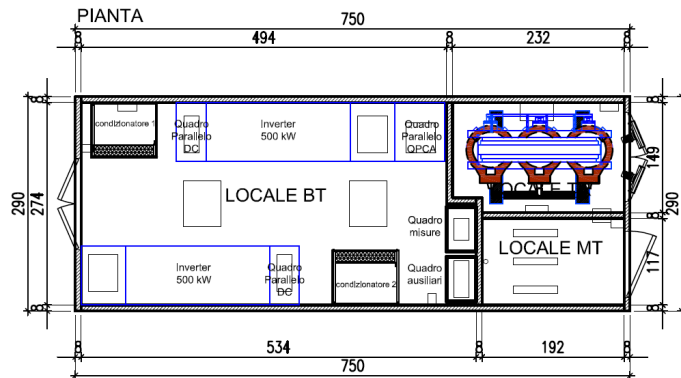

PIANTA COPERTURA

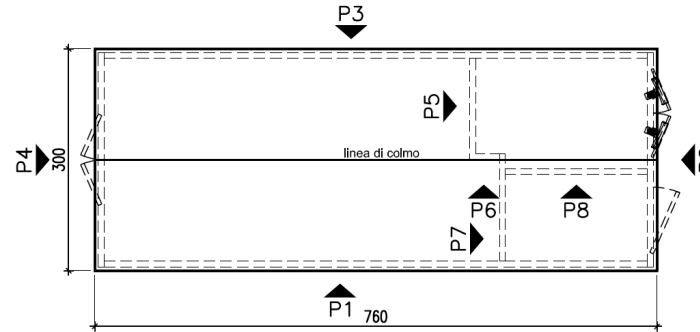

PROSPETTO P1

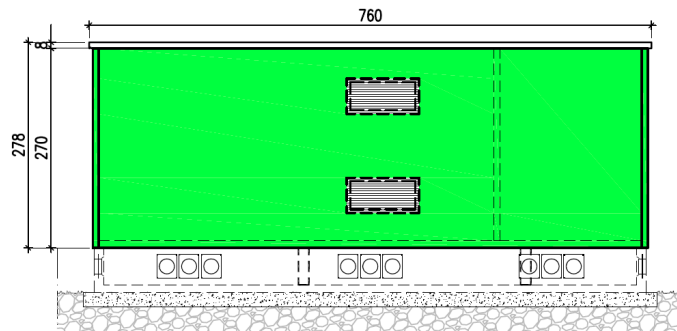

PROSPETTO P2

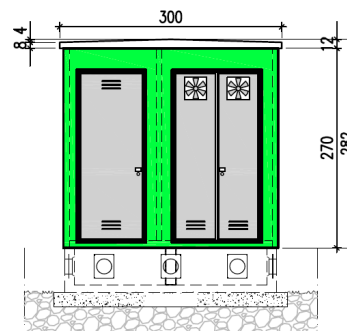

SEZIONE

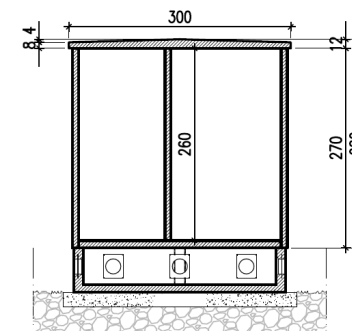

PROSPETTO P3

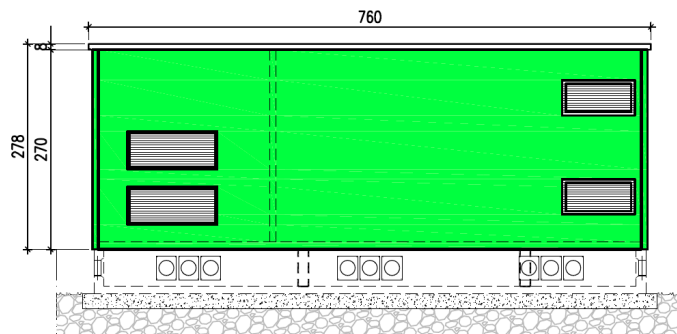

PROSPETTO P4

